

Tishk International University  
Mechatronics Engineering Department  
Engineering Drawing Lecture 1: 19/12 /2021



# Introduction To Engineering Drawing

PREPARED BY: SARA SARWER

EMAIL: [sara.sarwer@tiu.edu.iq](mailto:sara.sarwer@tiu.edu.iq)

# outline

- ▶ Syllabus
- ▶ Assessment
- ▶ What is Engineering Drawing
- ▶ Drawing Instruments
- ▶ Uses of the instrument tool



# Student's obligation

- ▶ student must attend lectures. And the students are not allow to enter the final exam with the attendance less than 80%.
- ▶ Students should bring all drawing tools and sharing tools are not allowed.
- ▶ Students should submit all the assignment on time.

# Role of Engineering Drawing

- ▶ 1. Ability to read and prepare engineering drawings.
- ▶ 2. Ability to make free - hand sketching of objects.
- ▶ 3. Power to imagine, analyse and communicate.



# What is Engineering Drawing

- ▶ An engineering drawing is a type of technical drawing that is used to convey information about an object . Engineering drawing is a two dimensional representation of three dimensional objects. In general, it provides necessary information about the shape, size, surface quality, material, manufacturing process.

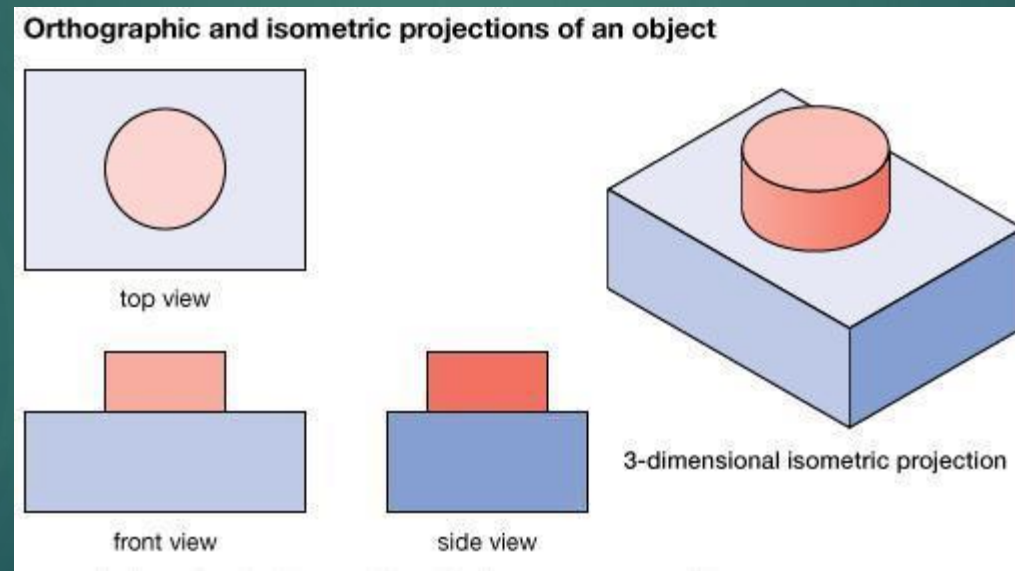

# Learning outcome

- 1 Get information about the important tools for engineering drawing. This will give student basic knowledge of technical drawings professions and means of communications to others.
- 2 Learning how to draw the shapes, angles and lines and others which is essential for engineer
- 3 Develop student's imagination and ability to represent the shape size and specifications of physical objects.

# Engineering Tools

- a) Drawing Board
- b) T-square or Drafter (Drafting machine)
- c) Set Squares
- d) Protractor
- e) Drawing Instrument Box(Sharpener, Tape ,Eraser ,compass,protractor)
- f) Drawing Sheet
- g) Drawing Pencils
- h) Drawing Pins/Clips
- I) Sharpener, Tape ,Eraser





# Drawing Instrument

- ▶ A drawing board (also drawing table, drafting table or architect's table) drawing boards used are made of well seasoned softwood of about 25 mm thick with a working edge for T-square.

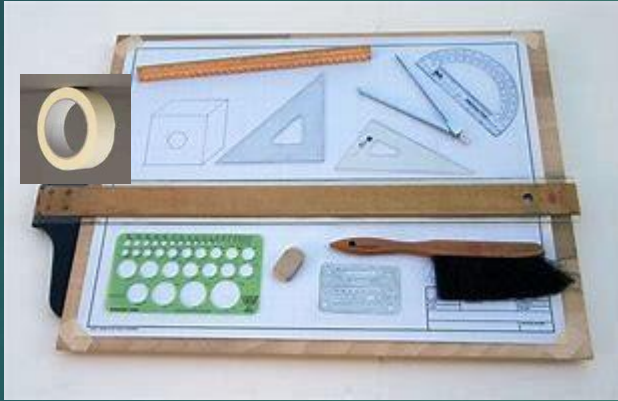

Figure Drawing Board



Figure Drawing Board

**T-square** consists of two parts namely the stock and the blade joined together at right angles to each other by means of screws and Pins stock is made to slide along the working edge and the Blade moves on the Drawing board. Primarily as a guide for drawing horizontal lines on a drafting table. It may also guide a set square to draw vertical or diagonal lines.



Figure T square



# Drawing sheet

- ▶ **Drawing sheet:** They are available in many varieties and good quality paper with smooth surface should be selected for Drawings which are to be preserved for longer time. Sizes of Drawing Sheets recommended by Bureau of Indian Standards (B.I.S) is given below,

Designation	Dimension, mm Trimmed size
A0	841 × 1189
A1	594 × 841
A2	420 × 594
A3	297 × 420
A4	210 × 297

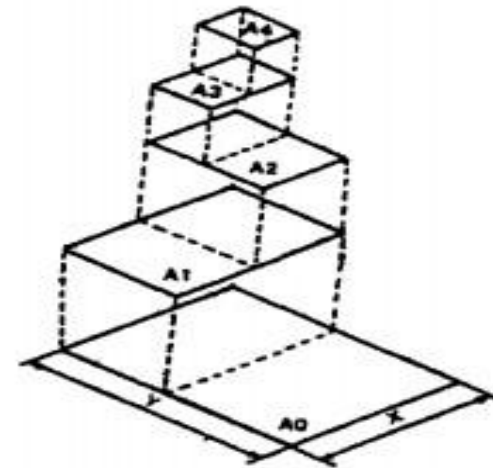

You will use A2 size for drawing

# Drawing Instrument

- ▶ **Set squares** are generally made from Plastic or celluloid material. They are triangular in shape with one corner, a right angle triangle. A pair of set squares ( $30^{\circ}$ – $60^{\circ}$ ) and  $45^{\circ}$  ( $45^{\circ}$  set square are generally provided with Protractor) facilitate marking of angles as shown in the following Figure;

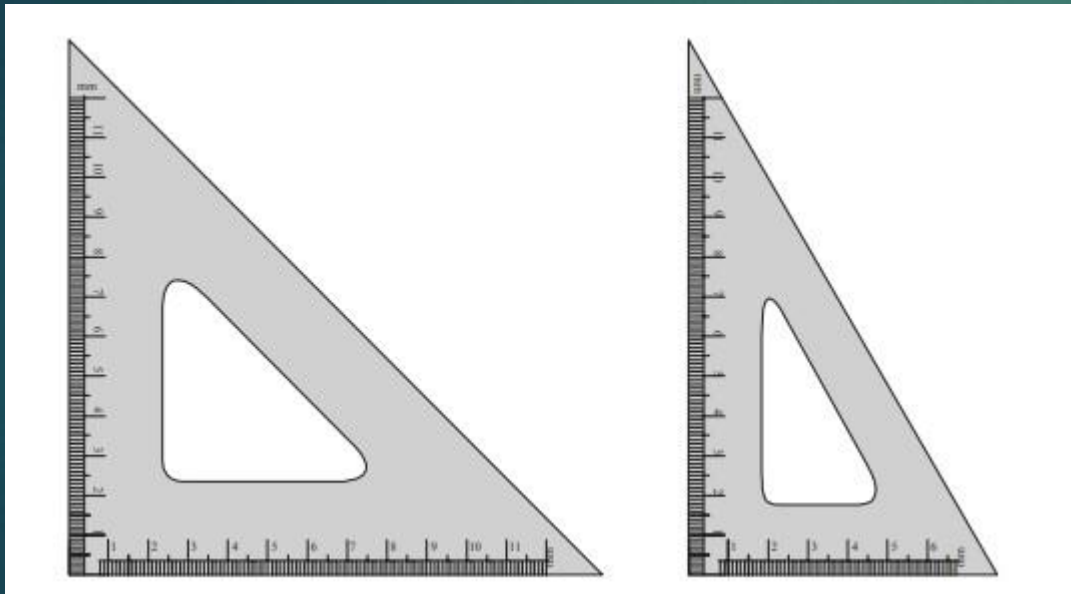

***30,60 degree  
Set Square***

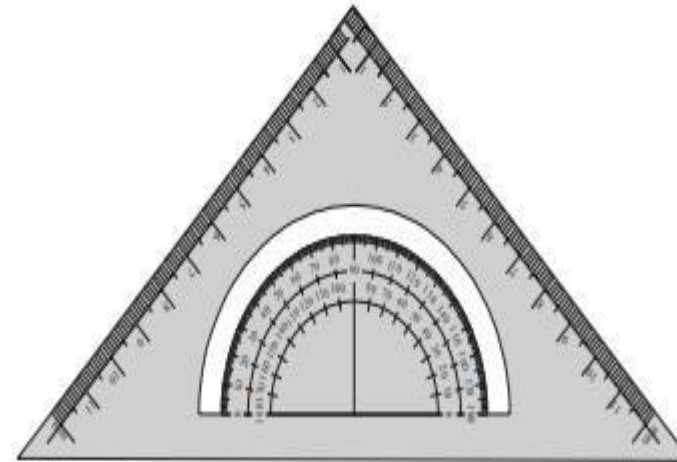

***45° Set Square with  
protractor***

# Protractors

- ▶ Protractors are used to mark or measure angles between  $0$  and  $180^\circ$ . They are semicircular in shape (of diameter 100mm) and are made of Plastic or celluloid which has more life. Protractors with circular shape capable of marking and measuring  $0$  to  $360^\circ$  are also available in the market

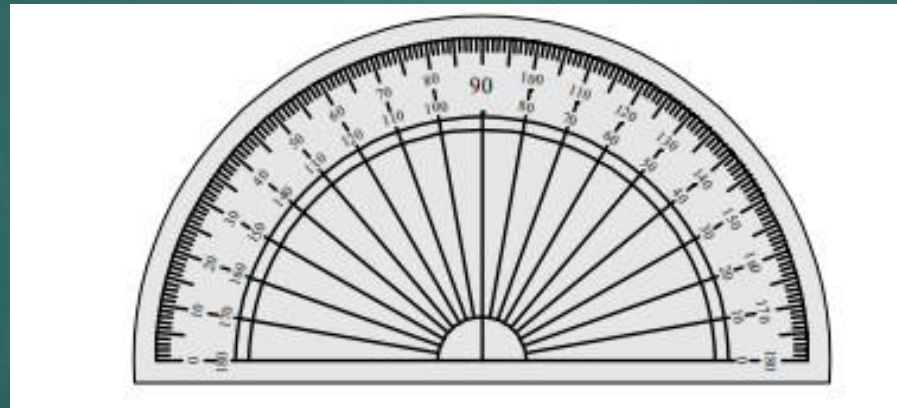
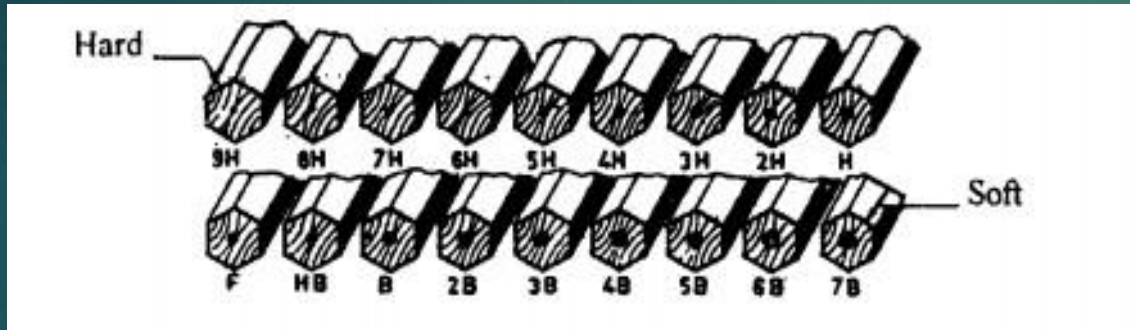

Figure:Protractor

# Pencils

- ▶ The accuracy and appearance of a Drawing depends on the quality of Pencil used to make Drawing. The grade of a Pencil lead is marked on the Pencil. HB denotes medium grade. Increase in hardness is shown by value put in front of H such as 2H, 3H etc., Softer pencils are marked as 2B, 3B, 4B etc. A Pencil marked 3B is softer than 2B and Pencil marked 4B is softer than 3B and so on. Beginning of a Drawing may be made with H or 2H. For lettering and dimensioning, H and HB Pencils are used.



HB :Soft grade for Border lines, lettering and free sketching  
H :Medium grade for Visible outlines, visible edges and boundary lines  
2H: Hard grade for construction lines, Dimension lines, Leader lines, Extension lines, Centre lines, Hatching lines and Hidden lines.

# Drawing Tools

- ▶ Drawing Pins and clips: These are used to fix the Drawing sheet on the Drawing board.
- ▶ Compass is used for drawing circles and arcs of circles. The compass has two legs hinged at one end. One of the legs has a pointed needle fitted at the lower end where as the other end has provision for inserting pencil lead.

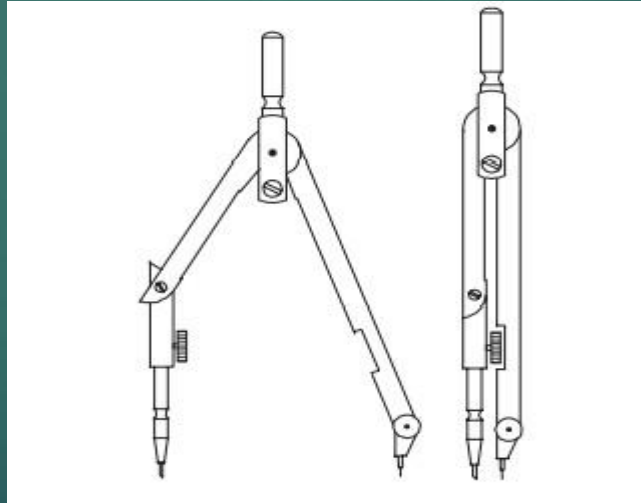

Compass



# French Curves

- ▶ French curves are available in different shapes . First a series of points are plotted along the desired path and then the most suitable curve is made along the edge of the curve. A flexible curve consists of a lead bar inside rubber which bends conveniently to draw a smooth curve through any set of points.

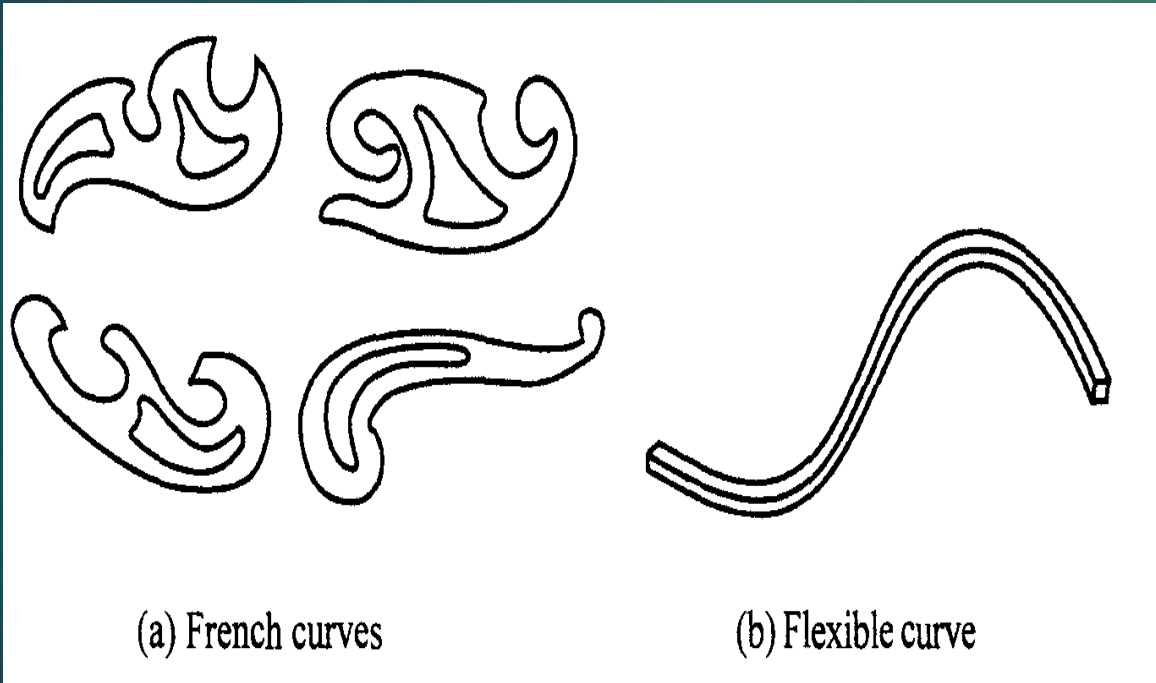

# Templates

- ▶ Templates these are aids used for drawing small features such as circles, arcs, triangular, square and other shapes and symbols used in various science and engineering fields

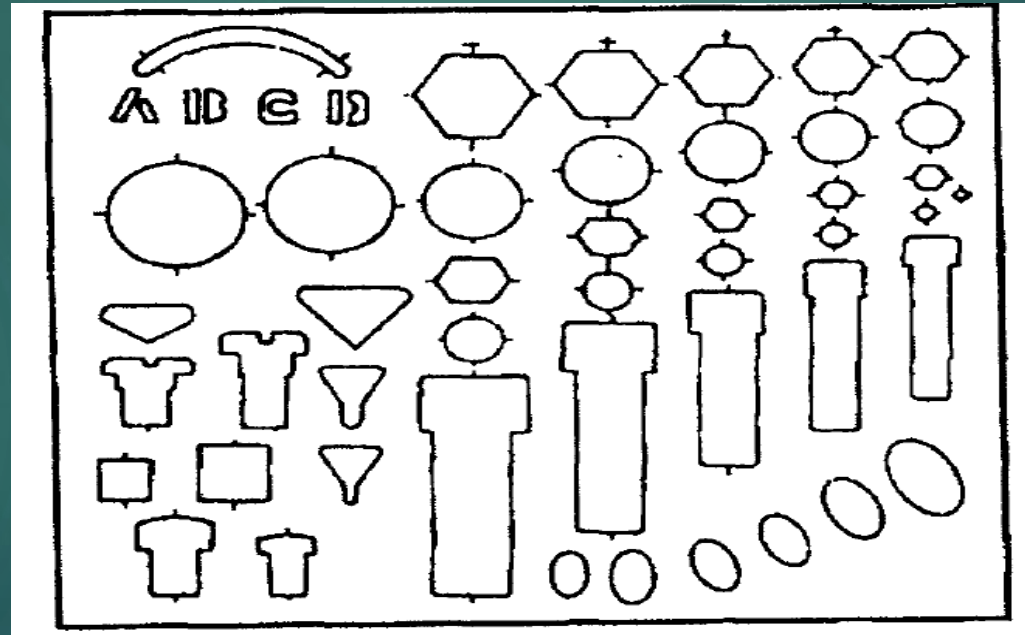



# Video

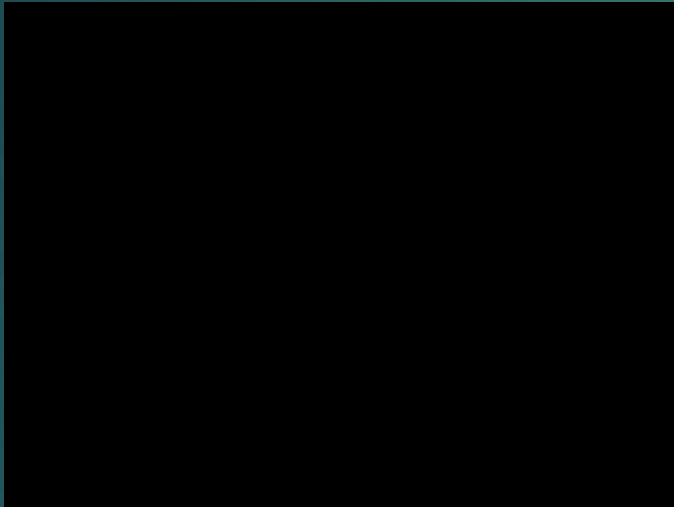

Video on Introduction to Engineering Drawing

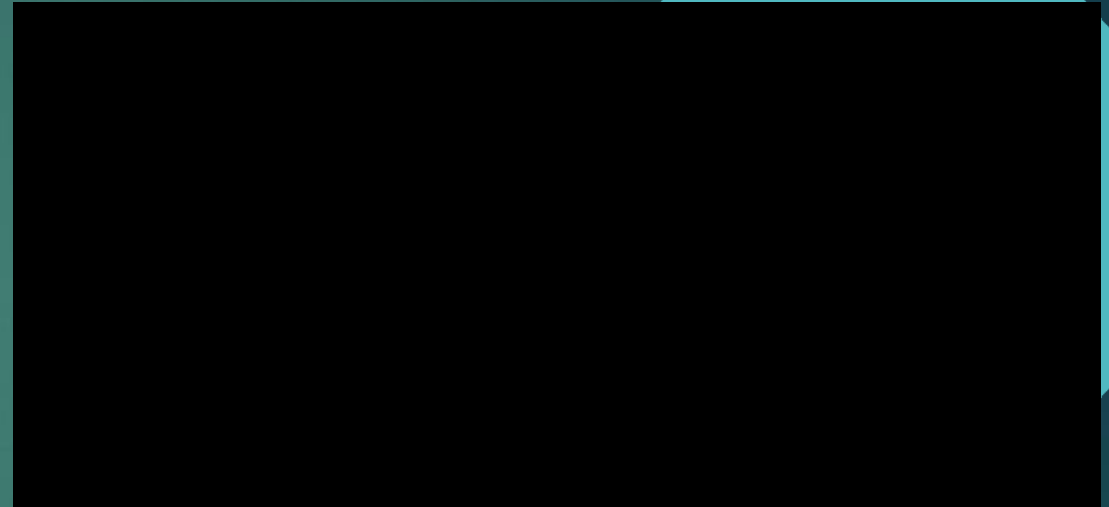

Video On Explaining Drawing Instrument

# Title Block

- ▶ Title Block The title block should lie within the drawing space at the bottom right hand corner of the sheet. The title block can have a maximum length of 150 mm providing the following information.
- ▶ 1. Title of the drawing.
- ▶ 2. Drawing number.
- ▶ 3. Scale.
- ▶ 4. Symbol denoting the method of projection.
- ▶ 5. Name of the firm
- ▶ 6. Initials of staff who have designed, checked and approved. The title block used on shop floor and one suggested for students class work are shown in

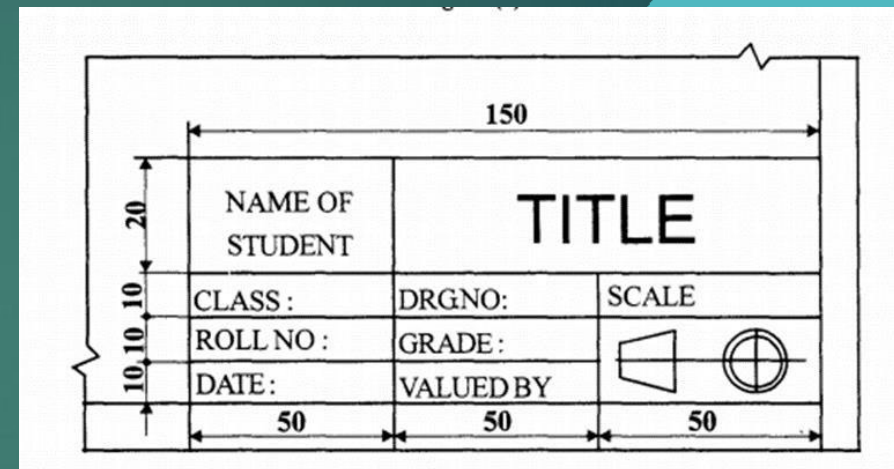

# Drawing Sheet Layout

- ▶ Drawing Sheet Layout The layout of a drawing sheet used on the shop floor is shown in Figure The layout suggested to students is

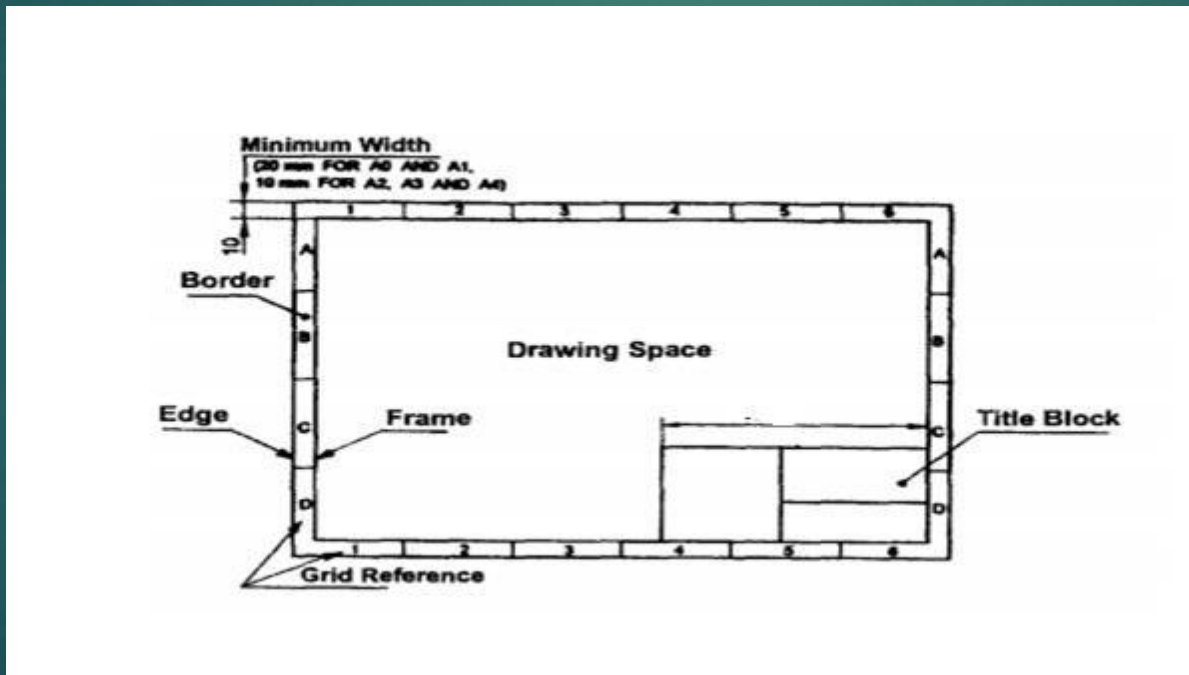

# Engineering Scale

- ▶ The relation between dimension on the drawing and the actual dimension.

Scales for use on technical drawings (IS : 46-1988)			
Category	Recommended scales		
Enlargement scales	50 : 1	20 : 1	10 : 1
	5 : 1	2 : 1	
Full size	1 : 1		
Reduction scales	1 : 2	1 : 5	1 : 10
	1 : 20	1 : 50	1 : 100
	1 : 200	1 : 500	1 : 1000
	1 : 2000	1 : 5000	1 : 10000



# Next Lecture

- ▶ Geometric construction



# Reference

- ▶ Textbook of Engineering Drawing Second Edition K. Venkata Reddy Prof. & HOD of Mechanical Engineering Dept. C.R. Engineering College, Tirupati - 517 506.
- ▶ Engineering Drawing Second Edition By A.W.Boundy
- ▶ [Introduction To Engineering Drawing - YouTube](#)